

SÉRIE 83000 / CONTENANTS

NO. DU MOULE	NO. D'ITEM	DESCRIPTION	QTÉ / BOÎTE	BOÎTES / PALETTE	QTÉ / PALETTE	TYPE DE RÉSINE	CAPACITÉ DE REMPLISSAGE
83250	136A	250 ml Blanc	500	36	18,000	PP	350 ml
83375	184A	375 ml Blanc	500	36	18,000	PP	494 ml
	184C	375 ml Transparent					
83500	137A	500 ml Blanc	500	27	13,500	PP	620 ml
83650	246A	650 ml Blanc	525	20	10,500	PP	835ml
83750	138A	750 ml Blanc	435	24	10,440	PP	900 ml
83000	181A	1000 ml Blanc	300	24	7,200	PP	1135 ml

+SÉRIE 83000 / COUVERCLES

NO. DU MOULE	NO. D'ITEM	DESCRIPTION	QTÉ / BOÎTE	BOÎTES / PALETTE	QTÉ / PALETTE	TYPE DE RÉSINE	PARTICULARITÉS
93000	419A	Concave Blanc	1,000	16	16,000	LLDPE	Couvercle concave pour usage général
11050	497A	Lisse Blanc	1,000	20	20,000	LLDPE	Recommandé pour scellage par opercule ou feuille d'aluminium
	497B	Lisse Naturel					



RÉUTILISABLE • RECYCLABLE
FABRIQUÉ AU CANADA

Plastipak

Moulé par
Injection

» SOLUTIONS D'EMBALLAGE. PRODUITS LAITIERS DE CULTURE.

SÉRIE 83000 / CONTENANTS

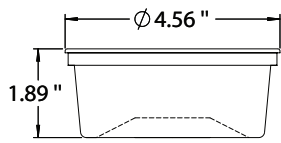

250 ml

83250

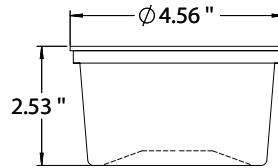

375 ml

83375

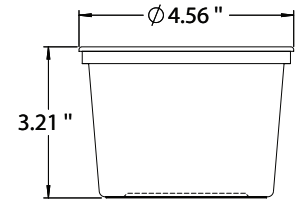

500 ml

83500

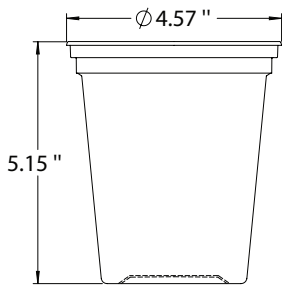

650 ml

83650

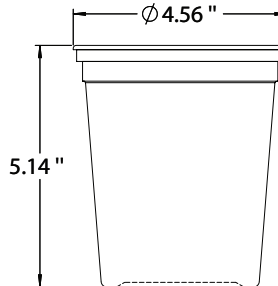

750 ml

83750

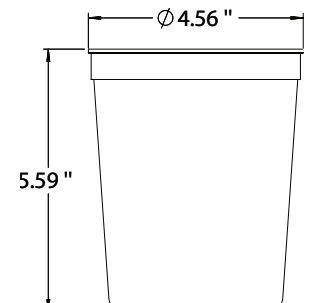

1000 ml

83000

+SÉRIE 83000 / COUVERCLES

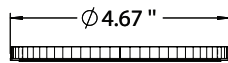

93000

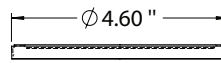

11050



RÉUTILISABLE • RECYCLABLE

FABRIQUÉ AU CANADA